

ARTIST



CONCEPT



SURALU
LE SUR-MESURE
ALUMINIUM



"Créativité
au service de
vos clients"

LE CONCEPT ARTIST

La gamme ARTIST est parfaitement adaptée à la conception et à la réalisation de verrières d'intérieur sur mesure. La finesse des profils en aluminium laqué renforce l'aspect cloison atelier recherché. Le nombre de configurations possibles permet une grande liberté de création et l'adaptation à de nombreux espaces intérieurs, cuisine, salon, hall, bureaux...



1

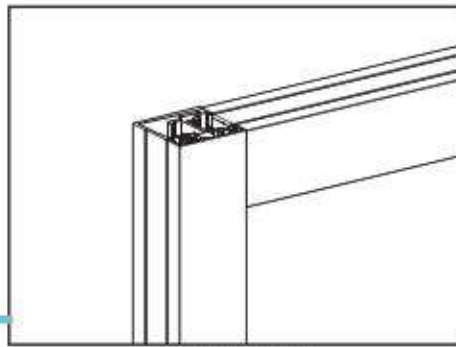

Assemblage cadre

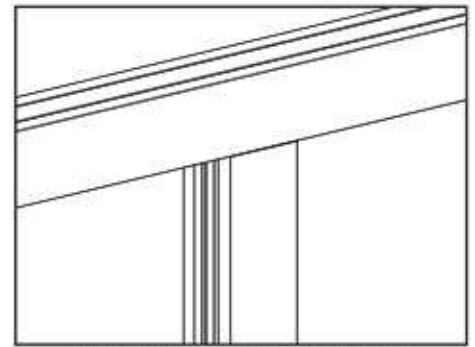

Assemblage cadre et traverse verticale



2

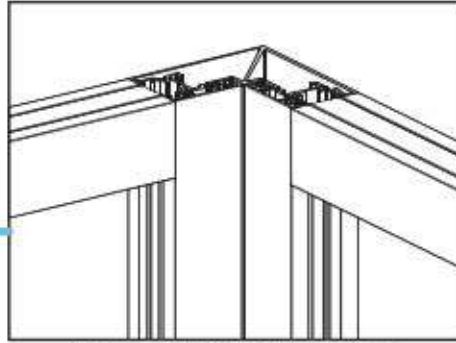

Assemblage cadre et poteau 2 départs

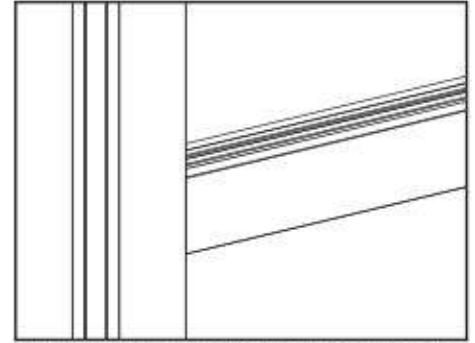

Assemblage traverse verticale et traverse horizontale



3

Assemblages

Tous les assemblages se font en coupes droites avec equerre.



4



Porte vitrée



Porte semi-vitrée



5



Porte semi-vitrée avec traverses verticales

Ouvrants

• Trois configurations pour les ouvrants

STRUCTURE

- 1 - Cadre
- 2 - Traverse
- 3 - Poteau 2D
- 4 - Parcloses
- 5 - Huisserie



+ PRODUIT

Une grande variété de configurations possibles pour structurer tous les espaces.

1 - Univers cuisine.

2 - Univers nuit.

3 - Univers jour.

4 - Univers tertiaire.

MATIÈRE/FINITION

| | Matières | Finitions |
|---------|-----------|------------------|
| Profils | Aluminium | Laqué Noir sablé |



Structure

Cadre verrière

Longueur / Length: 5300 / 2550 mm

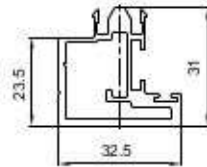

• Réf / Art. no. 50MT01-U / 50MT01-Z

Parclose verrière

Longueur / Length: 5300 / 2550 mm

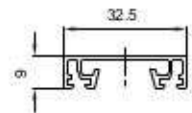
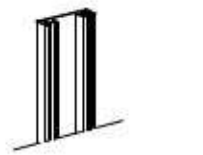

• Réf / Art. no. 50PR01-U / 50PR01-Z

Traverse verrière

Longueur / Length: 5300 / 2550 mm

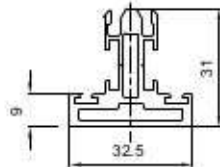

• Réf / Art. no. 50TR01-U / 50TR01-Z

Poteau 2D verrière

Longueur / Length: 5300 / 2550 mm

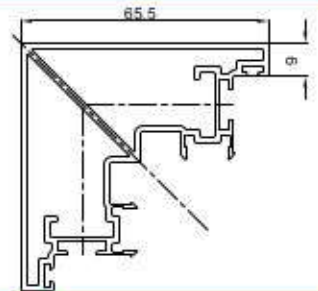
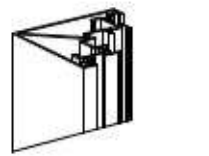

• Réf / Art. no. 50PT01-U / 50PT01-Z

Huisserie verrière

Longueur / Length: 5400 mm

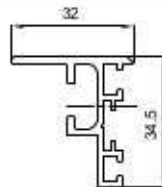

• Réf / Art. no. 50HC01-L

Kit equerres cage 2.5x13

Quantité / Quantity: x4

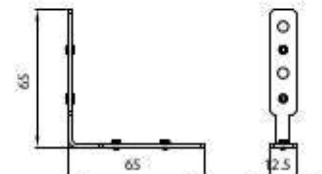

• Réf / Art. no. 90KA02

Joint PVC pour parclose alu

Longueur / Length: 6030 mm

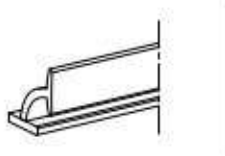

• Réf / Art. no. 606000-M

Porte

Montant porte Artist

Longueur / Length: 6400 mm

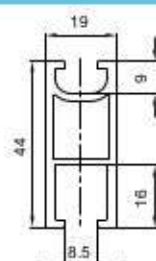

• Réf / Art. no. MOPS/064

Equerre à viser 15x15 mm

Longueur / Length: 6000 mm

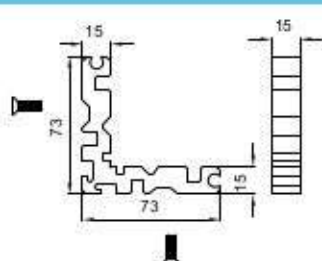

• Réf / Art. no. 411615

Porte / Door

Traverse porte Artist

Longueur / Length: 6100 mm



• Réf / Art. no. 202032

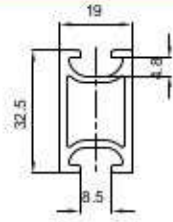

Bloc d'assemblage 15x15 mm à 90°

Quantité / Quantity: x1



• Réf / Art. no. 401715

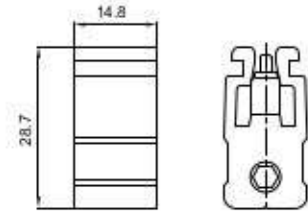

Kit paumelle à clamer

Quantité / Quantity: x1

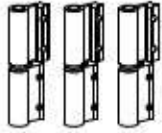

• Réf / Art. no. 90KA01

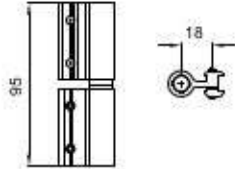

Serrure à rouleau sans cylindre

Quantité / Quantity: x1



• Réf / Art. no. 50SR01

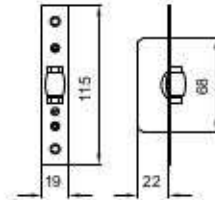

Cale bois de vitrage 3mm

Quantité / Quantity: x1

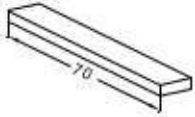

• Réf / Art. no. 624/000

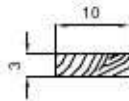

Joint a bourrer 2 mm

Quantité / Quantity: vente au détail par mètre linéaire / retail sale by linear meter

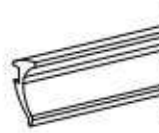

• Réf / Art. no. 120008DT



Kit poignée de tirage "aileron"

Quantité / Quantity: x1

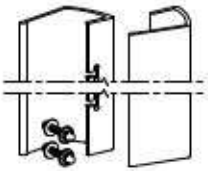

• Réf / Art. no. 50KA01



Poignée de tirage "aileron"

Quantité / Quantity: x1



• Réf / Art. no. 50AC01

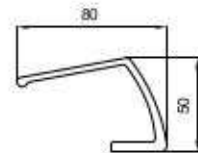

Kit fixation poignée "aileron"

Quantité / Quantity: x1



• Réf / Art. no. 50AC02

Outils / Tools

Clé clippage verrière

Quantité / Quantity: x1



• Réf / Art. no. 50OU01

Cache rainure PVC

Quantité / Quantity: vente au détail par mètre linéaire / retail sale by linear meter



• Réf / Art. no. 301115DT

